

CERTIFIED TESTING LABORATORIES

Architectural Division • 7252 Narcoossee Rd. • Orlando, FL 32822
(407) 384-7744 • Fax (407) 384-7751
Web Site: www.ctlarch.com
E-mail: ctlarch.com

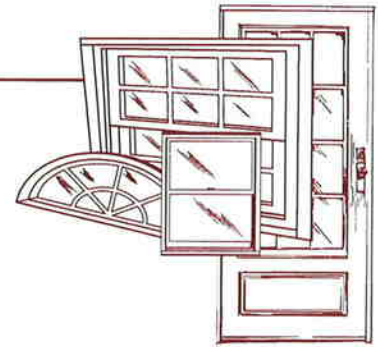

Report No.: CTLA-1743W-1
Report Date: September 20, 2007

STRUCTURAL PERFORMANCE TEST REPORT

Test Requested By - Glass Craft Door Co.
2002 Brittmoore Rd.
Houston, Texas 77043

Tests Conducted: ASTM E 330-02 "Test Method for Structural Performance of Exterior Windows, Curtain Walls and Doors by Uniform Static Air Pressure Difference."

Test Specimen

Design Pressures Out-swing + 35.0psf -30.0psf (With surface bolts)

(1) DESCRIPTION OF SERIES:

Model Designation 6'-0" x 8'-0" Portobello/Estancia Arch Top Hardwood Double Glazed Doors
Out-swing

Overall Size

& Configuration: Two (2) Operable Out-swing Panels 74.000" wide x 99.000" high overall- X/X

No. & Size of Doors

(1) Active Arch Top (2/3 lite panel) 36.000" wide x 96.000" high
(1) Passive Arch Top w/astragal (2/3 lite panel) 36.750" wide x 96.000" high

(2) MATERIAL CHARACTERISTICS:

Materials - Hardwood panels, header, jambs, and astragal with an aluminum composite filled fixed Out-swing threshold by Endura (As stated by manufacturer).

Frame Construction -

The double door frame consists of two (2) hinge jambs, one (1) header, and one (1) sill/threshold. Reference drawing #(Portobello/Estancia ARCH CTL-004). The frame is constructed of solid kerfed hardwood and measured 4.625" wide x 1.250" thick. The frame head is mortised and butted to the side jambs and attached with four (4) #8 x 3.000" Phillips C.S. Wood Screws on each side. The threshold was mortised and butted and attached to the side jambs with three (3) #8 x 3.000" Phillips C.S. Wood Screws on each side. The sill is an aluminum fixed composite filled standard out-swing threshold that measured 5.750" wide x 1.500" high manufactured by Endura. Both hinge jambs are notched for four (4) 4.000" butt hinges.



Panel Construction: One (1) wood "T" Astragal was located on the lock-stile of the passive panel and (2/3 Passive Lite) was constructed of one (1) piece solid hardwood. The wood "T" Astragal measured 1.406" wide x 3.125" high x full length of panel. The "T" astragal was secured to the lock stile of the passive panel with 1.500" brad nails and an adhesive compound. The active and passive panels were constructed as follows.

One (1) top rail measured 6.500" wide by 24.500" long by 1.750" thick and constructed with solid hardwood pieces glued together with a hardwood laminate (0.19" thick) adhered to the surface.

One (1) intermediate rail measured 6.500" wide by 24.500" long by 1.750" thick and constructed with solid hardwood pieces glued together with a hardwood laminate (0.19" thick) adhered to the surface.

One (1) Hinge-stile measured 6.0625" wide by 96.000" high by 1.750" thick and constructed with solid hardwood pieces glued together with a hardwood laminate (0.19" thick) adhered to the surface.

One (1) lock-stile measured 6.0625" wide by 89.000" high by 1.750" thick and constructed with solid hardwood pieces glued together with a hardwood laminate (0.19" thick) adhered to the surface.

One (1) bottom rail measured 9.500" wide by 24.500" long by 1.750" thick and constructed with solid hardwood pieces glued together with a hardwood laminate (0.19" thick). Top rail utilized two (2) hard wood dowel (.500" x 5.000") construction with adhesive compound secured to the lock stile and the hinge stile. Intermediate rail utilized two (2) hard wood dowel (.500" x 5.000") construction with adhesive compound secured to the lock stile and the hinge stile. Bottom rail utilized four (4) hard wood dowel (.500" x 5.000") construction with adhesive compound secured to the lock stile and the hinge stile. The door panel was constructed of solid hardwood held into the stiles and rails with cope and stick construction. Panel measured 12" high x .875" thick. Ref. Dwg. #(Portobello/Estancia ARCH CTL-004).



Panel Construction: One (1) top rail measured 6.500" wide by 24.500" long by 1.750" thick and constructed with solid hardwood pieces glued together with a hardwood laminate (0.19" thick) adhered to the surface.

One (1) intermediate rail measured 6.500" wide by 24.500" long by 1.750" thick and constructed with solid hardwood pieces glued together with a hardwood laminate (0.19" thick) adhered to the surface.

One (1) Hinge-stile measured 6.0625" wide by 89.000" high by 1.750" thick and constructed with solid hardwood pieces glued together with a hardwood laminate (0.19" thick) adhered to the surface.

One (1) lock-stile measured 6.0625" wide by 96.000" high by 1.750" thick and constructed with solid hardwood pieces glued together with a hardwood laminate (0.19" thick) adhered to the surface.

One (1) bottom rail measured 9.500" wide by 24.500" long by 1.750" thick, and constructed with solid hard wood pieces glued together with a hardwood laminate (0.19" thick). Top rail utilized two (2) hard wood dowel (.500" x 5.000") construction with adhesive compound secured to the lock stile and the hinge stile. Intermediate rail utilized two (2) hard wood dowel (.500" x 5.000") construction with adhesive compound secured to the lock stile and the hinge stile. Bottom rail utilized four (4) hard wood dowel (.500" x 5.000") construction with adhesive compound secured to the lock stile and the hinge stile. The door panel was constructed of solid hardwood held into the stiles and rails with cope and stick construction. Panel measured 12" high x .875" thick. Ref. Dwg. # (Portobello/Estancia ARCH CTL-004).

Glazing Method: -

One (1) active, one (1) passive panel (2/3 clear lite panel) consisted of : .500" overall tempered glass glazed consisting of : **One (1) interior lite:** .125" Tempered glass, .250" spacer system with an with a "U" shaped rubber insert. **One (1) exterior lite:** .125" Tempered glass. Tempered glass glazed with Tremco "Dynamic" Polyurathane with a .500" glazing bite. Glass was captured on the interior perimeter with one (1) pieces of decorative hardwood molding strips that measured 1.419" wide x 1.030" high. Each piece of molding was secured to hinge and lock stiles and 18 Ga x 1.500" Brad nails. Reference drawing # (Portobello/Estancia ARCH CTL-010).

Daylight Opening -

- (1) Active (2/3 lite panel) 21.625" wide x 55.875" high
- (1) Passive (2/3 lite panel) 21.625" wide x 55.875" high

Weather-stripping

Q-Lon weather-stripping located on the jambs, header, and Astragal.
One (1) piece length of each side jamb and (1) piece length of astragal. (2) four fin vinyl bottom door sweeps one per each panel secured with staples to the bottom of the panels.

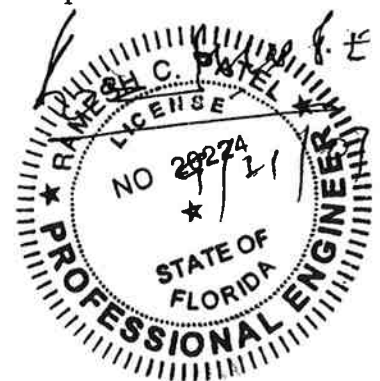

Hardware - Four (4) 4" x 4" Penrond 5/8" radius hinges per each hinge stile of the active and passive panel secured to the fixed stile utilizing four (4) # 8 x 1.000" Phillips flat head S.M.S. and frame jamb utilizing two (2) # 8 x 3.000" and two (2) # 8 x 1.000" Phillips flat head S.M.S. located at 11.000", 33.250", 55.750" and 78.000" c/l measuring from the top of each panel to the bottom . One (1) Slege door knob and one (1) Slege Deadbolt Grade II were inserted into a wood lock box on the lock stile of operable door. The handle set was located at 36.000" centerline from the bottom of the door panel and the deadbolt was located at 41.500" centerline from the bottom of the door panel. The metallic latch strikes for the handle set and deadbolt were located at 36.000" and 41.500" centerline from the bottom of the frame latch jamb. Specimen utilized four steel Surface bolts located at the top and bottom of active and passive door panel that measured .750" wide x 8.000" long. The surface bolts were Rockwood 580 type steel and were thru-bolted to the exterior of the lock and latch stiles with four (4) 10/32 x 1.000" Phillips F.H. Sex Bolts. There were four metallic strike plates for surface bolts to insert with two (2) at the frame head and two (2) at the sill/threshold. Reference drawing # (Portobello/Estancia ARCH CTL-003)..

Weepholes - N/A

Muntins - N/A

Reinforcement - N/A

Sealant - Silicone caulking as needed to seal unit into rough opening.
All hairline joints between the frames were sealed with Tight Bond II Exterior Marine glue.

Additional Description -

Specimen was installed in a 2" x 12" S.P.F. wood test buck.

(3) INSTALLATION:

Screws and Method of Attachment – The specimen was secured to the 2" x 12" S.P.F. wood test buck as follows: Reference drawing # (Portobello/Estancia ARCH CTL-016).

Eight (8) # 8 x 3.000" Phillips flat head wood screws per each frame jamb (two per each hinge location) to the wood buck located at located at 9.000", 12.000", 31,000", 34.000", 53.500", 56.500, 76.000" and 79.000" measuring from frame head to frame sill/threshold.

Six (6) #10 x 3.000" Phillips flat head wood screws in the frame head– Located at 8.000", 19.000", 35.000", 42.000", 54.000" and 66.000" measuring from left jamb to right jamb.

Eight (8) # 8 x 1.250" Phillips C/S flat head S.M.S. at Frame Sill/ Threshold – Located at 6.000", 14.000", 23.000", 32.000", 41.000", 50.000", 59.000" and 68.000" measuring from left jamb to right jamb.

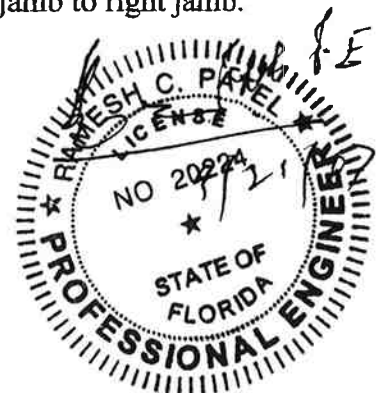

Performance Test Results

<u>Paragraph</u>	<u>Title of Test</u>	<u>Method</u>	<u>Measured</u>	<u>Allowed</u>
ASTM E330-02				
2.1.4.2/4.4.2	Uniform Load Structural Permanent Deformation	Ten (10) second duration		
(D/P + 35)	@ 52.5 psf Positive	Loc #1	0.050"	0.384"
(D/P - 30)	@ 45.0 psf Negative	Loc #1	0.110"	0.384"

Location (1) - Max. allowable Perm. Set after test load at center mid-span of the vertical astragal (0.4% of 96" span) = 0.384"

Note: Unit was tested with surface bolts on the top and bottom of active and passive panel.

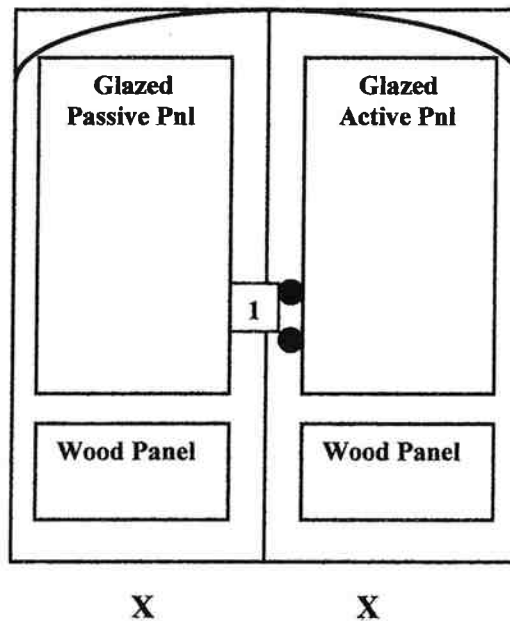

Test Date: September 12, 2007 thru September 14, 2007.

(5) DRAWINGS TO BE SUBMITTED:

- .1. Portobello/Estancia ARCH-CTL-001 thru Portobello/Estancia ARCH-CTL-0017.

Comment: Nominal 2-mil polyethylene film was used to seal against leakage during structural loads. The film was used in a manner that did not influence the test results.

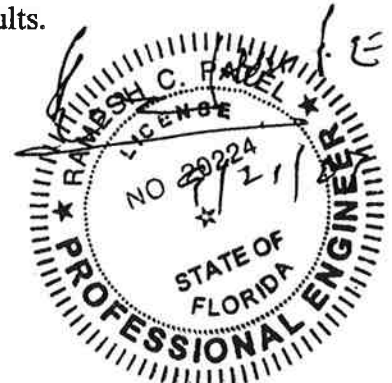

Remarks: The results obtained and reported apply only to the specimens tested.

Detailed drawings were available for laboratory records and comparison to the test specimen at the time of this report. A copy of this report along with representative sections of the test specimen will be retained by CTL for a period of four (4) years. The results obtained apply only to the specimen tested.

This test report does not constitute certification of this product, but only that the above test results were obtained using the designated test methods and they indicate compliance with the performance requirements (paragraphs as listed) of the above referenced specifications.

Certified Testing Laboratories assumes that all information provided by the client is accurate and that the physical and chemical properties of the components are as stated by the manufacturer.

Certified Testing Laboratories, Inc.

Observers:

Gene Denley- Glass Craft Door Co.

All Tests Certified and Witnessed by

Ramesh Patel- P.E.

Ted Scanlon- CTL

Steve Gibbs- CTL

Gary Nations- CTL

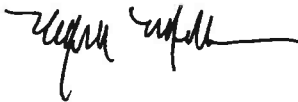

Michael Miller
Senior Laboratory Technician
Architectural Division

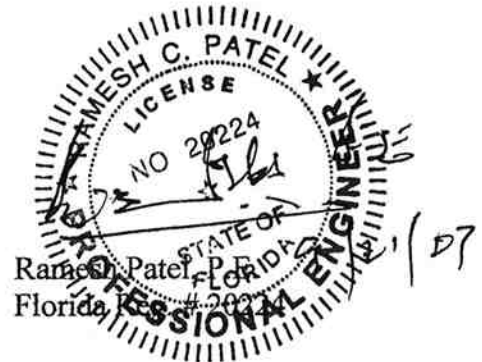

- Cc: Glass Craft Door Co. (2)
- NAMI (1)
- Ramesh Patel (1)
- File (1)

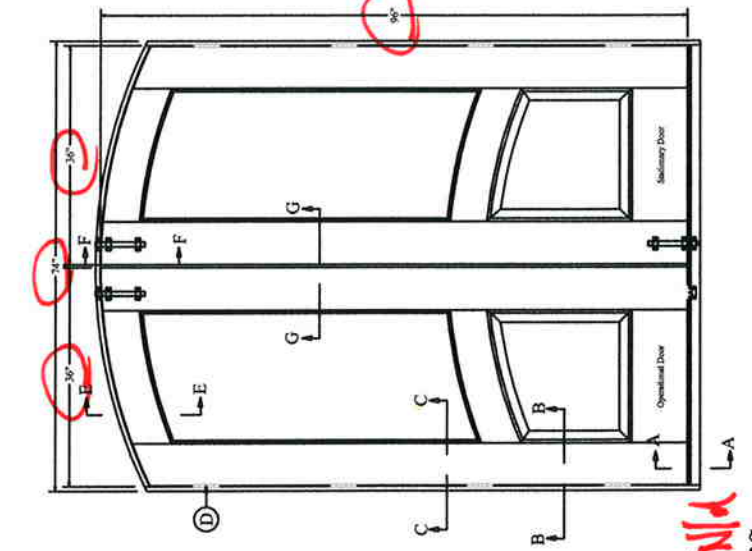

ELEVATION

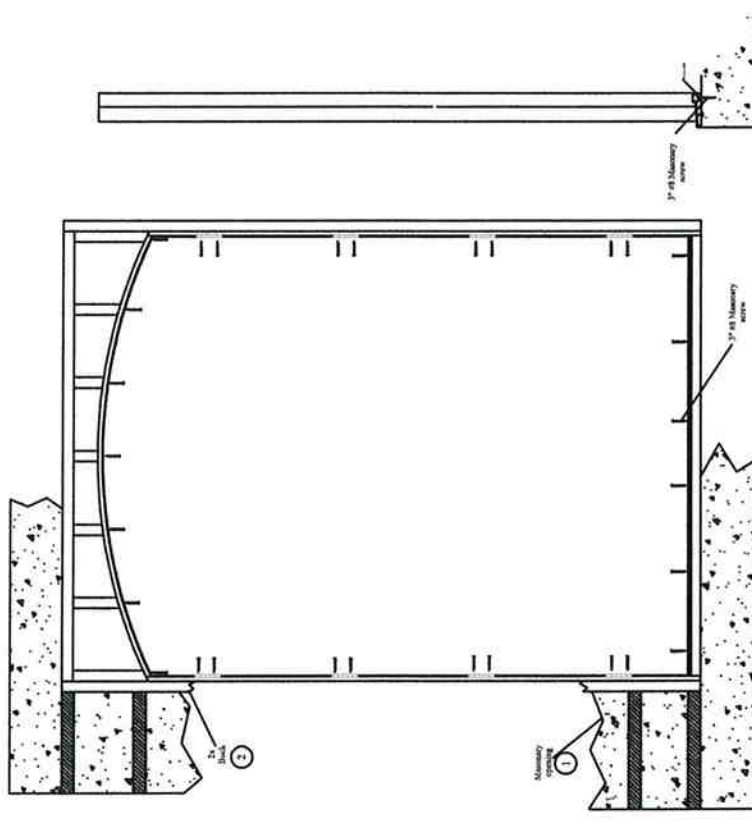

ANCHORING LAYOUT

Set frame sill in concrete or bed of caulk

Out Swing In Swing

Inside View / In swing & Out Swing



CTL ESTIMATING LABORATORIES
ARCHITECTURAL DIVISION
 7252 NARCOOSSEE ROAD
 ORLANDO, FLORIDA 32822

Glass*Craft
 Portobello / Estancia Arch Top
 Hardwood Double Glazed Doors

CTLA No: 1743W-1
 Date Verified: 9.24.07
 Verified By: K-10

CTLA-001

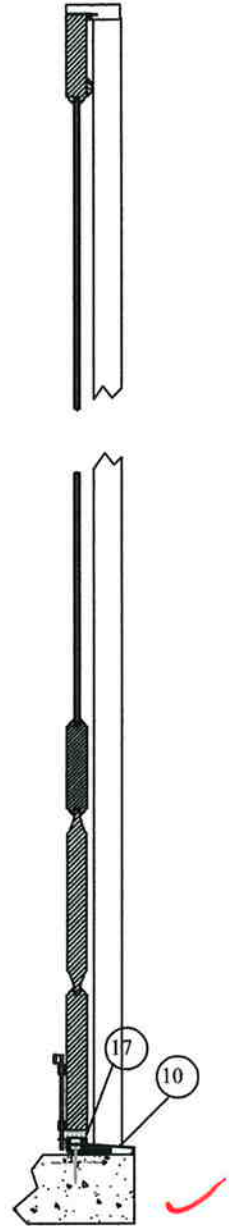

Section
H-H



CTL
CERTIFIED TESTING LABORATORIES

ARCHITECTURAL DIVISION
7252 NARCOOSSEE ROAD
ORLANDO, FLORIDA 32822

CTLA No. 1743w-1743w-1
Date Verified: 9-24-07
Verified By: K-10

Glass*Craft

Portobello / Estancia Arch Top
Hardwood Double Glazed Doors

CTL
002

List of Material

Item #	Discription	Material
1	Masonry	CONC.
2	2x Buck	Wood
3	Astrical	Wood
4	Schlage lock Set	Metal
5	Rockwood Surface Bolts #580	Metal
6	Top Header	Wood
7	Penrond 4"x4" 5/8" Radius Hinge	Metal
8	Glass	Glass
9	Panel	Wood
10	Endura Sill ZAIL 5866 / I/S	Alum.
11	3" #9 Wood screw	Metal
12	#9x1" PFH Wood Screw	Metal
13	1/4 Round Trim	Wood
14	Endura Sill ZAIL 5866 / O/S	Alum.
15	Stile	Wood
16	Door Jam	Wood
17	Bottom Door sweep	Rubber
18	10-32 Sex Bolt	Metal
19	Bottom Rail	Wood
20	weather strip	Foam

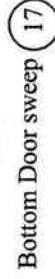
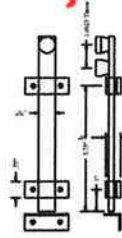
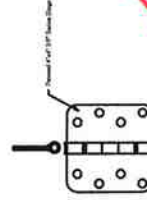
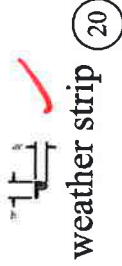
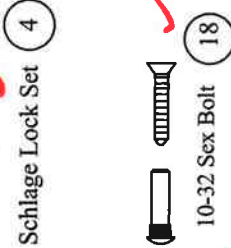
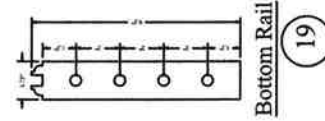
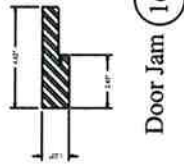
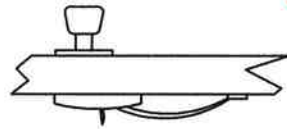
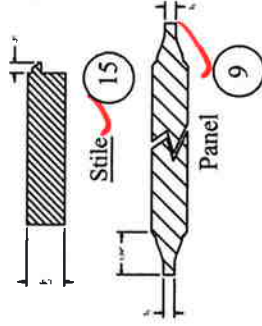
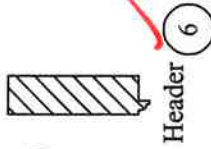

CTLA No. 1743W-1
 Date Verified: 9-24-07
 Verified By: K-ID



Glass*Craft

Portobello / Estancia Round Top
 Hardwood Double Glazed Doors

— CTL
 003

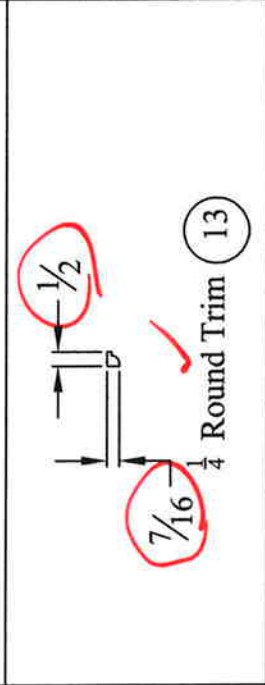
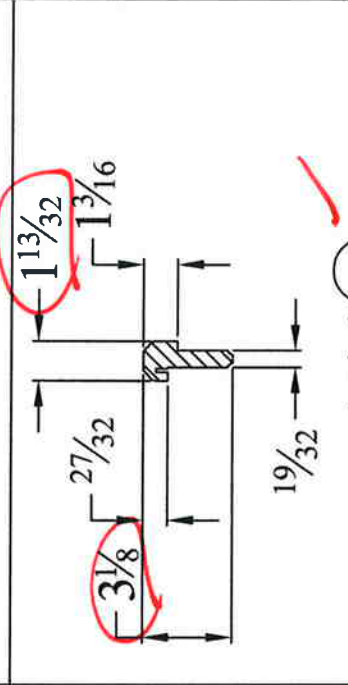
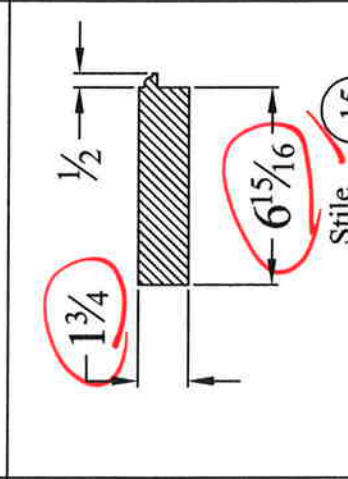
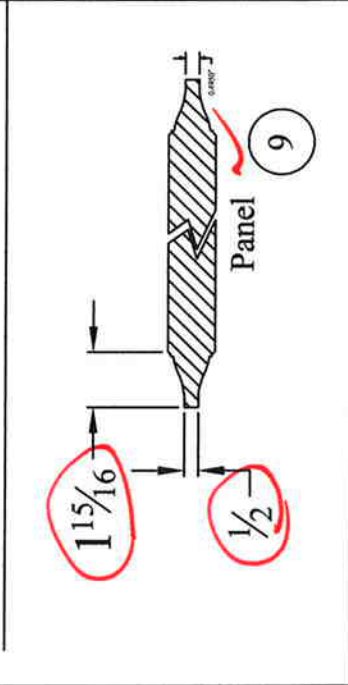
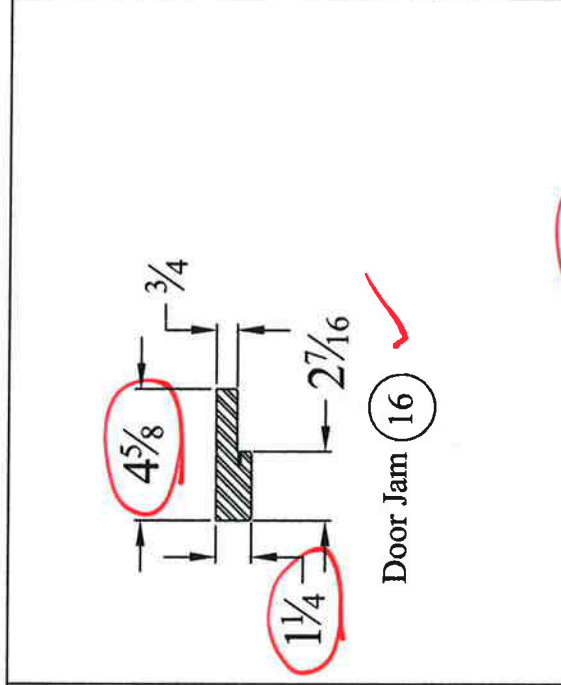
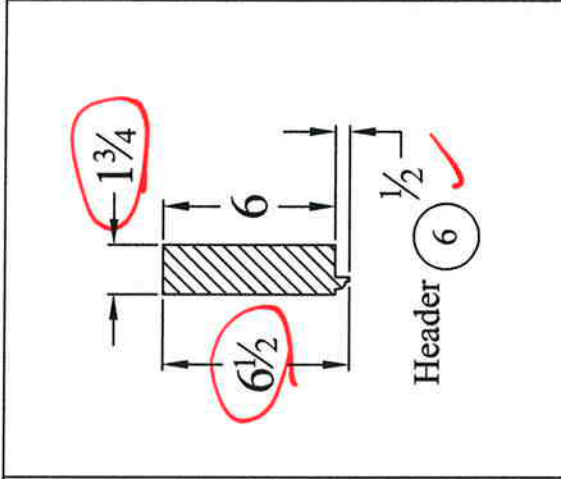
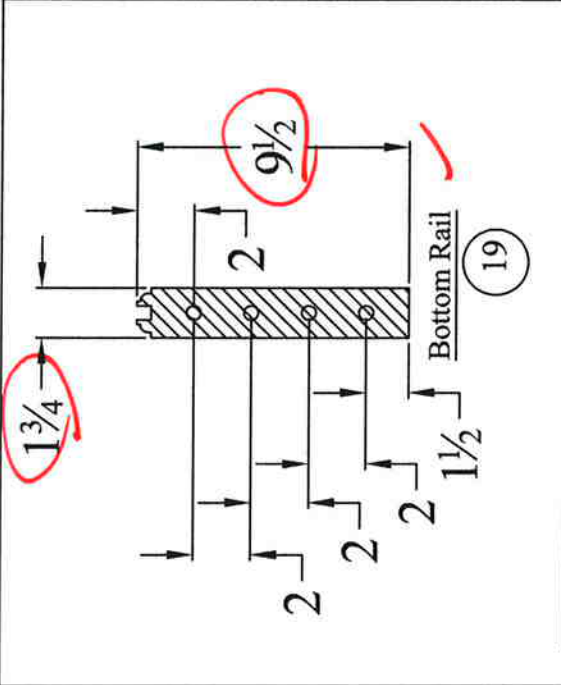

-CTL
004

Glass*Craft
Portobello / Estancia Arch Top
Hardwood Double Glazed Doors

CTL ESTIMATING LABORATORIES
ARCHITECTURAL DIVISION
7252 NARCOOSSEE ROAD
ORLANDO, FLORIDA 32822

CTLA No. **1743W-1743W-1**
Date Verified: **9.24.07**
Verified By: **K-10**

-CTL
005

Glass*Craft

Portobello / Estancia Arch Top
Hardwood Double Glazed Doors

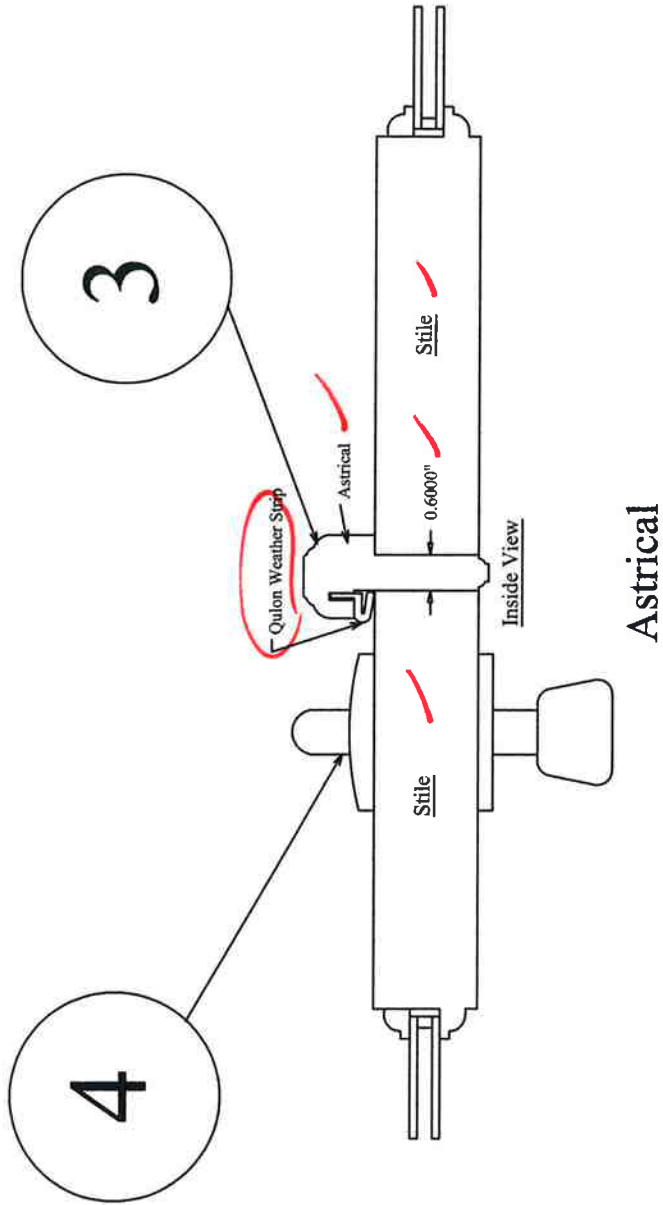

(G)



ARCHITECTURAL DIVISION
7252 NARCOSSEE ROAD
ORLANDO, FLORIDA 32822

CTLA No. 1743W-1743W-J
Date Verified: 9.24.07
Verified By: K.10

Astrical

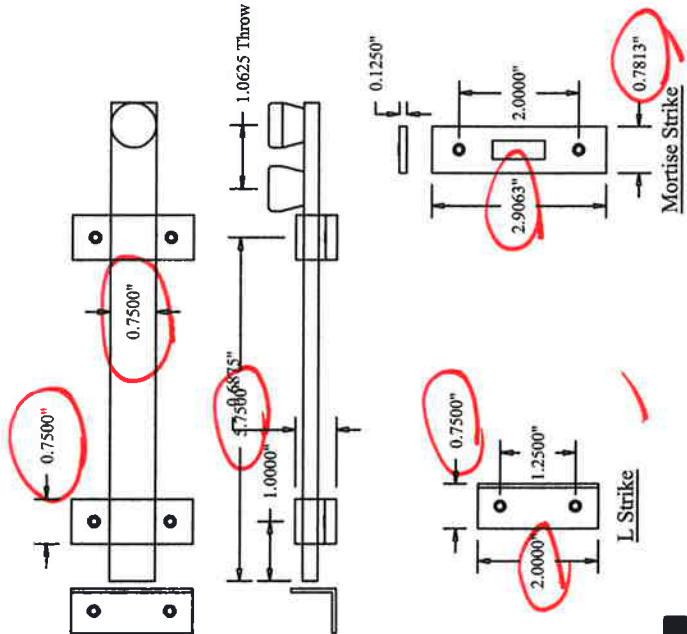
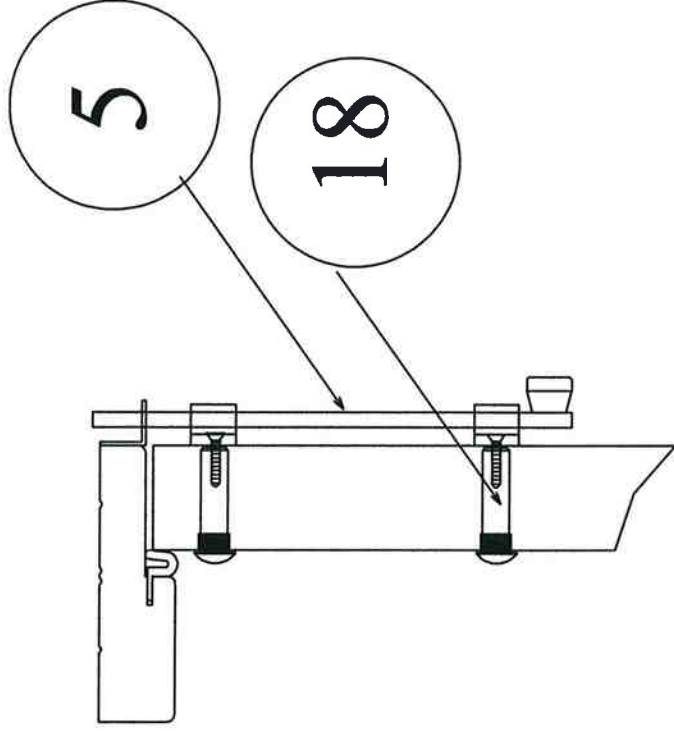

CTLA
 CERTIFIED TESTING LABORATORIES
 ARCHITECTURAL DIVISION (F)
 7252 NARCOSSEE ROAD
 ORLANDO, FLORIDA 32822

CTLA No. 1743W-1743w-1
 Date Verified: 9-24-07
 Verified By: K-10

Rockwood 580 Surface Bolt

Glass*Craft
 Portobello / Estancia Arch Top
 Hardwood Double Glazed Doors

CTL
 006

Glass*Craft

Portobello / Estancia Arch Top
Hardwood Double Glazed Doors

-CTL
007

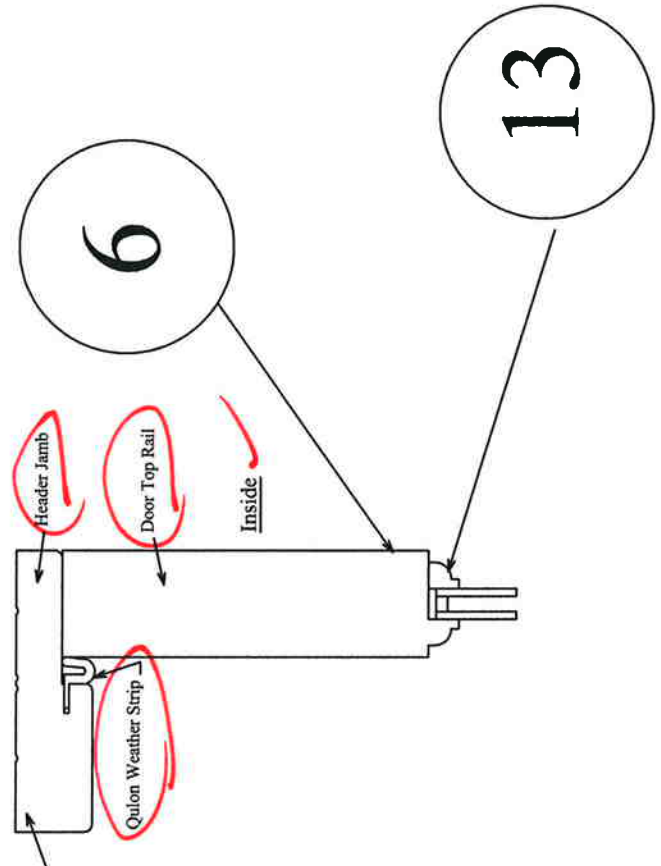

(E) Header



ARCHITECTURAL DIVISION
7252 NARCOOSSEE ROAD
ORLANDO, FLORIDA 32822

CTLA No. 1743w-1743w-1

Date Verified: 9.24.07

Verified By: K.10



CTL
CERTIFIED TESTING LABORATORIES

ARCHITECTURAL DIVISION
7252 NARCOOSSEE ROAD
ORLANDO, FLORIDA 32822

CTLA No. 1743w-1743w-1

Date Verified: 9-24-07

Verified By: K-10

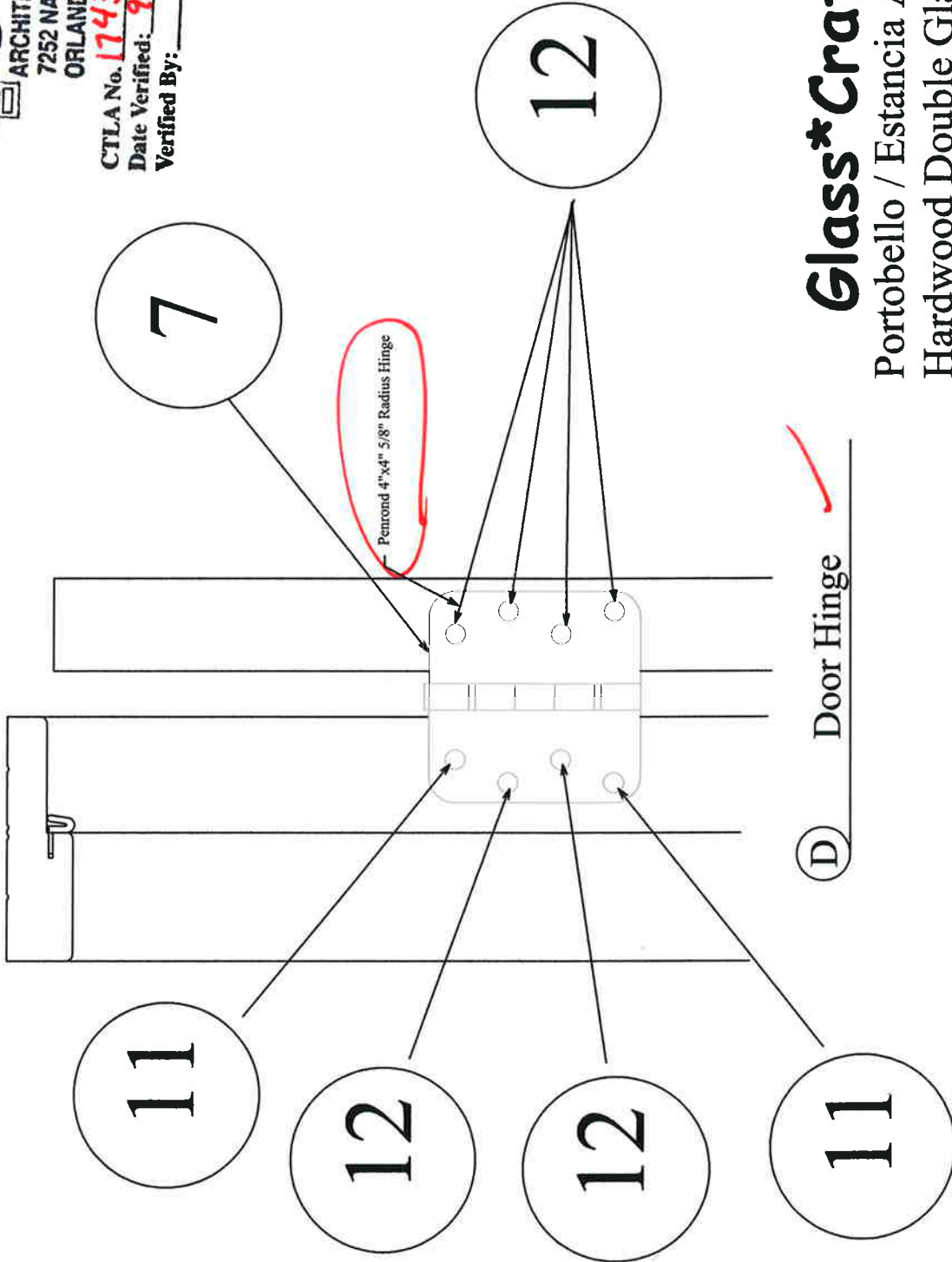

ⓓ Door Hinge ✓

Glass*Craft

Portobello / Estancia Arch Top
Hardwood Double Glazed Doors

—CTL
008

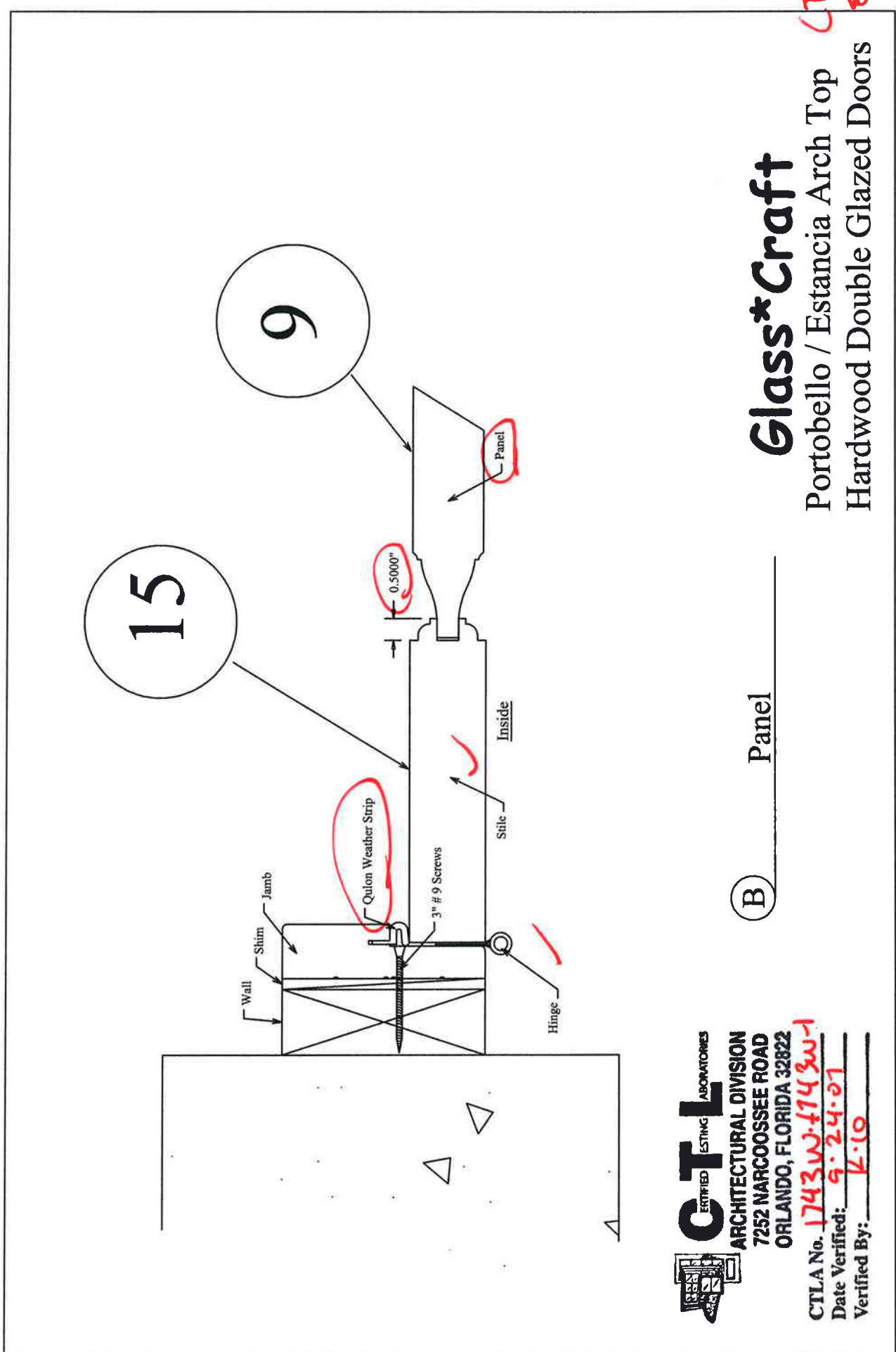

Glass*Craft

Portobello / Estancia Arch Top
 Hardwood Double Glazed Doors

(B) Panel

CTL ESTIMATED LABORATORIES
 ARCHITECTURAL DIVISION
 7252 NARCOOSSEE ROAD
 ORLANDO, FLORIDA 32822
 CTLA No. 1743W-1743W-1
 Date Verified: 9-24-07
 Verified By: K-10

CTL
 009



ARCHITECTURAL DIVISION
7252 NARCOOSSEE ROAD
ORLANDO, FLORIDA 32822

CTLA No. 1743W-1743W-1

Date Verified: 9-24-07

Verified By: K-10

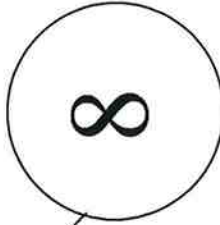
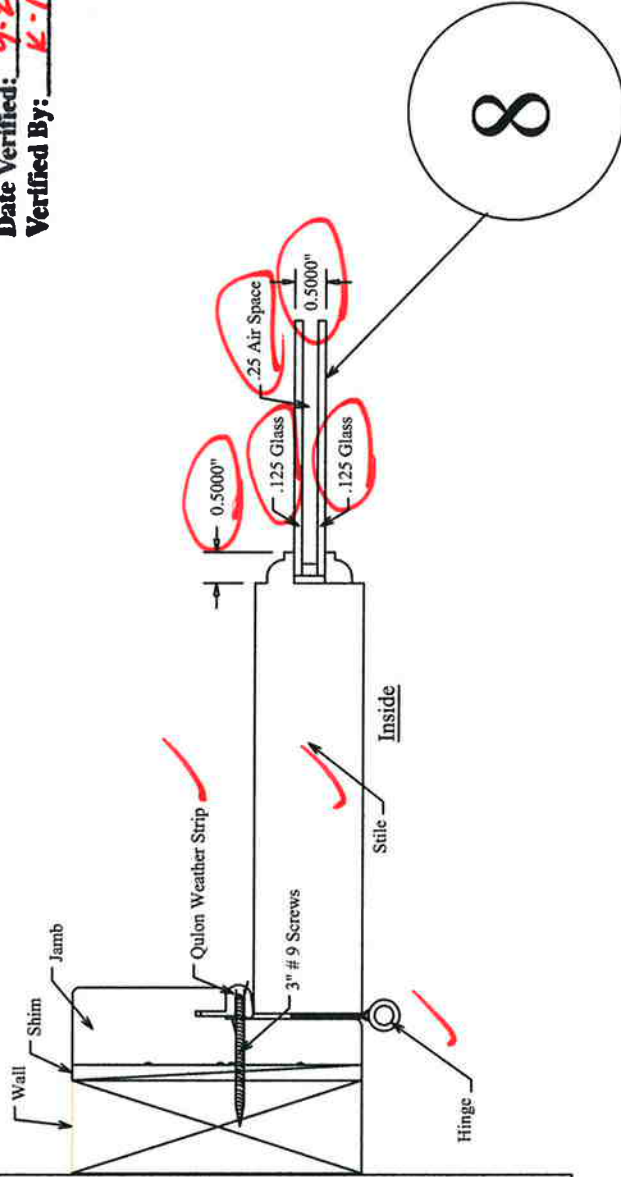
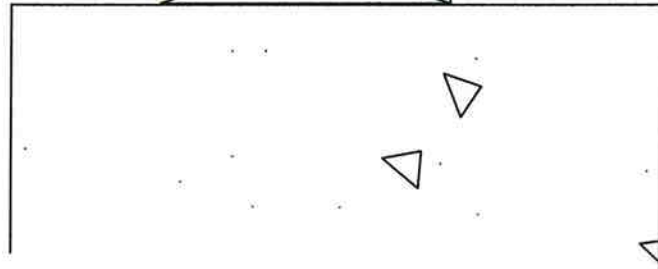

③ Glass ✓

Glass*Craft

Portobello / Estancia Arch Top
Hardwood Double Glazed Doors

CTC
~~010~~
010

CTLA No. 1743W-1
 Date Verified: 9-24-07
 Verified By: K-10

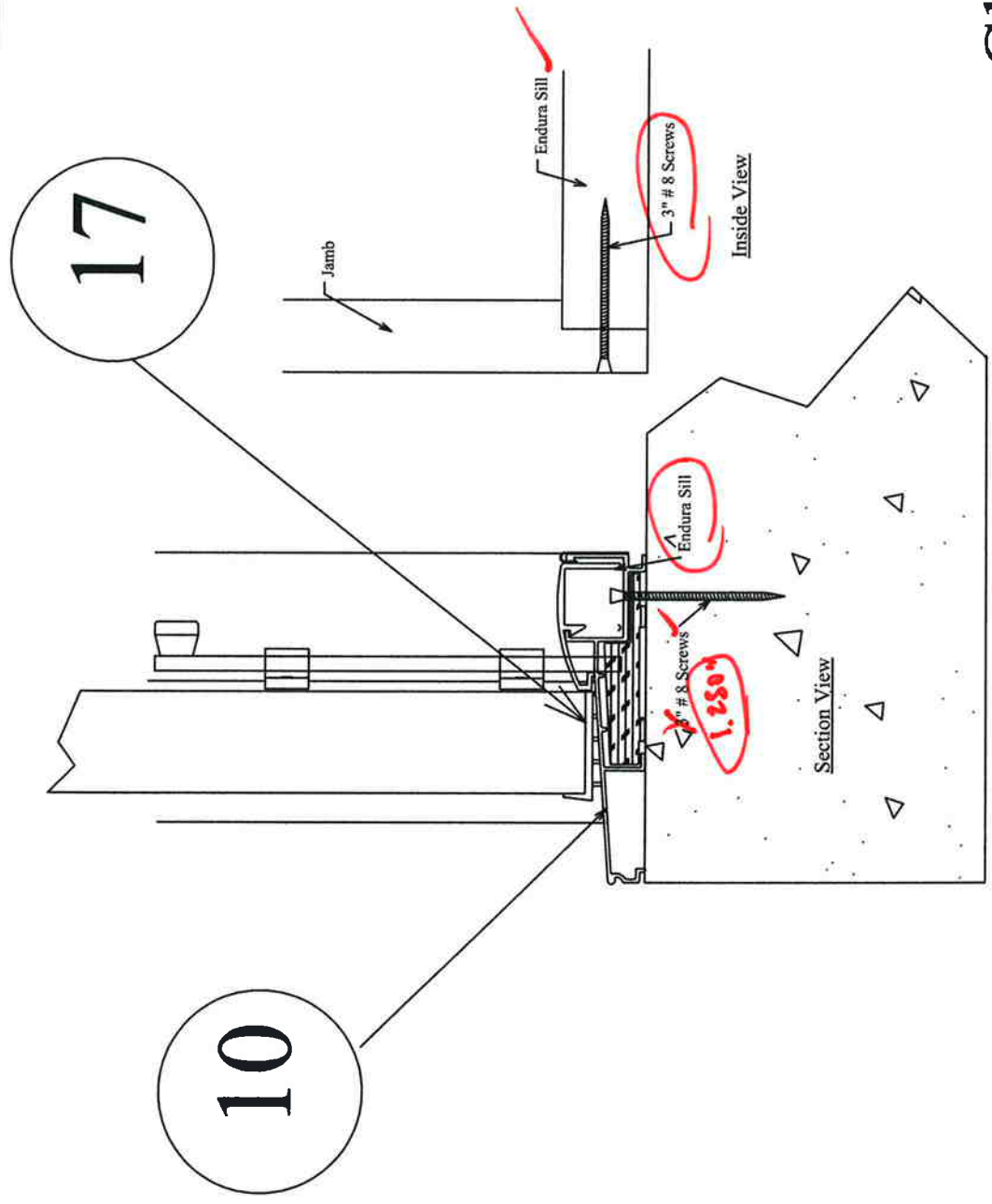

Glass*Craft

Portobello / Estancia Arch Top
 Hardwood Double Glazed Doors

CTL
 012

Endura Sill ✓

ZAIL 5866 / O/S

Ⓐ Threshold Out Swing

Penrond 4"x4" 5/8" Radius Hinge

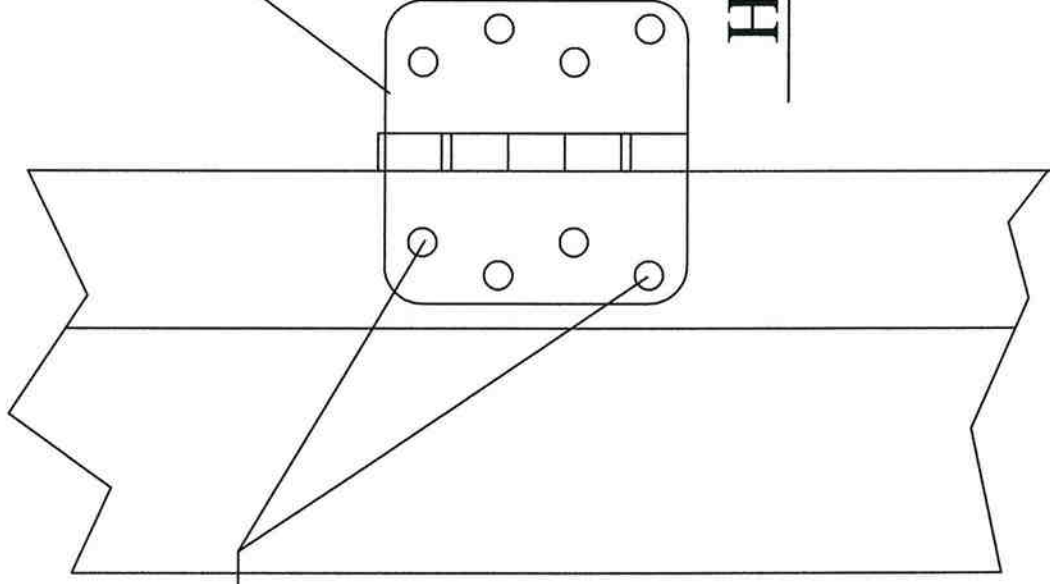

Hinge Detail

Install (2) 3" #8 Wood Screws Per Henge.



7252 NARCOOSSEE ROAD
ORLANDO, FLORIDA 32822

CTLA No. 1743W-1743W-1
Date Verified: 7-24-07
Verified By: K-10

Glass*Craft
Portobello / Estancia Arch Top
Hardwood Double Glazed Doors

CTL
013

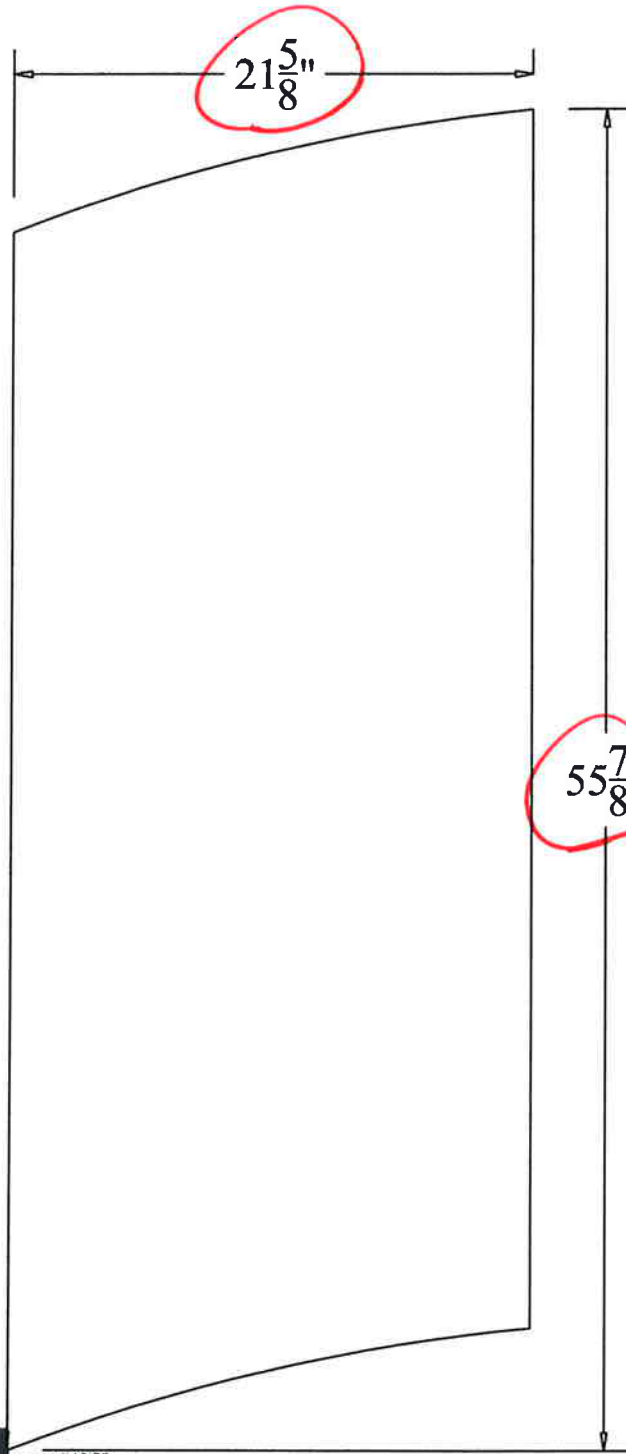

CTLA
CERTIFIED TESTING LABORATORIES

ARCHITECTURAL DIVISION
7252 NARCOOSSEE ROAD
ORLANDO, FLORIDA 32822

CTLA No. 17431W-1743W-1
Date Verified: 9-24-07
Verified By: K-10

Glass*Craft

Portobello / Estancia Arch Top
Hardwood Double Glazed Doors

- CTL
014

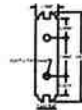
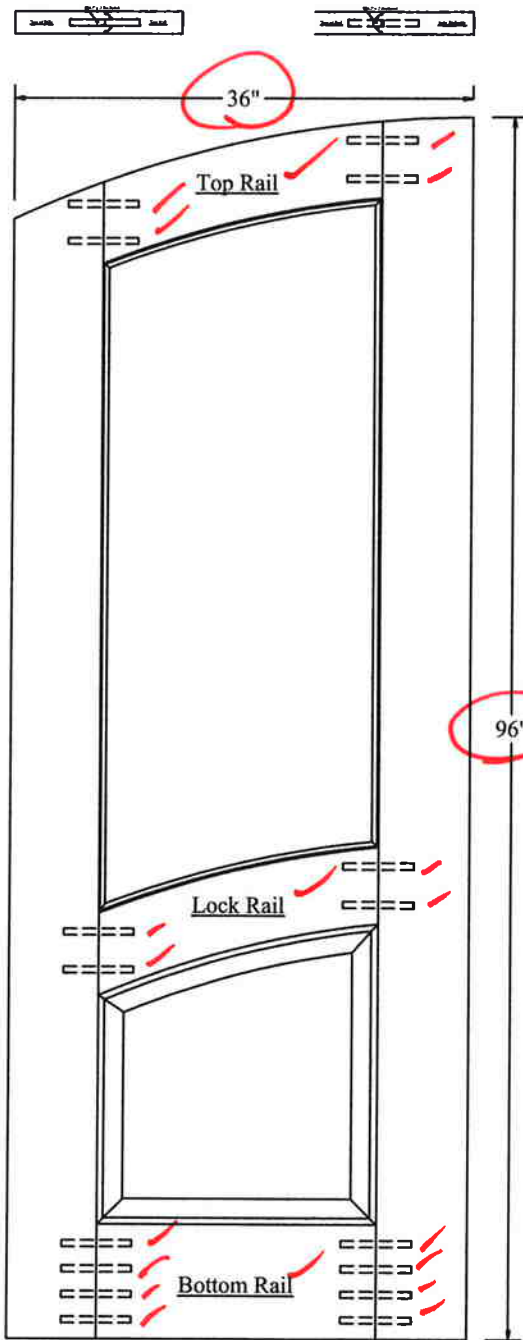

CTL
 CERTIFIED TESTING LABORATORIES
 ARCHITECTURAL DIVISION
 7252 NARCOOSSEE ROAD
 ORLANDO, FLORIDA 32822

CTLA No: 1743W-1743W-1
 Date Verified: 9.24.07
 Verified By: K-10

Glass*Craft
 Portobello / Estancia Arch Top
 Hardwood Double Glazed Doors

CTL
 OIS

Glass*Craft

Portobello / Estancia Arch Top
Hardwood Double Glazed Doors

CTLA No. 1743W-1743W-1
Date Verified: 9.24.07
Verified By: K. 18
ARCHITECTURAL DIVISION
7252 NARCOOSSEE ROAD
ORLANDO, FLORIDA 32822
CTLA ESTIMATED LABORATORIES

ANCHORING DIMENSION

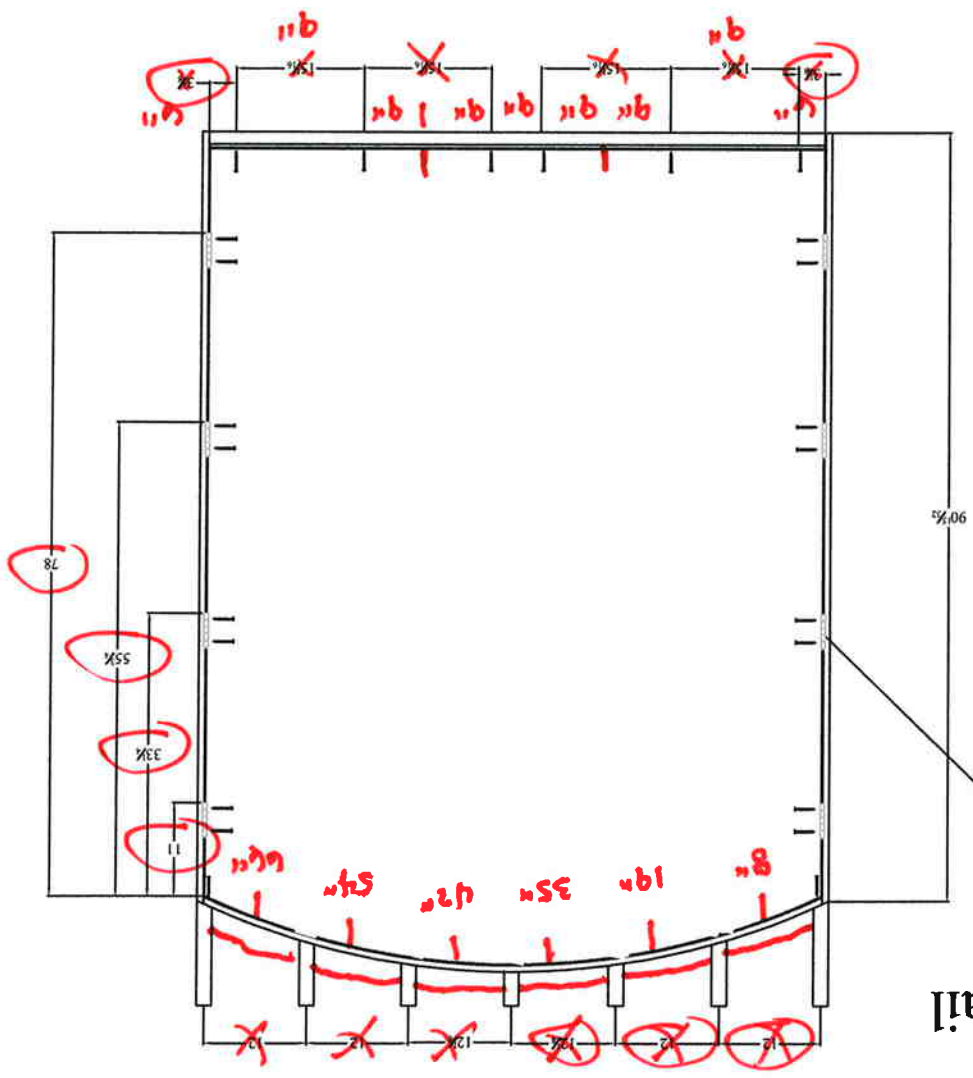

CTLA
016

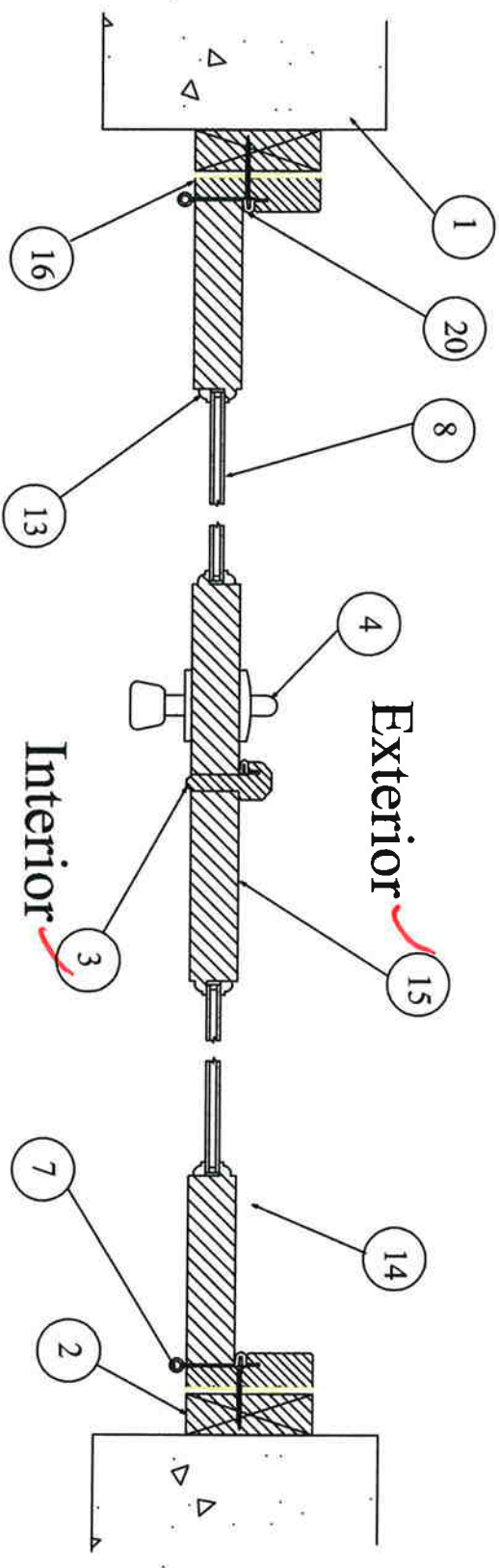

Horizontal Cross Section

Glass*Craft

Portobello / Estancia Arch Top
 Hardwood Double Glazed Doors

CTL ARCHITECTURAL DIVISION
 7252 NARCOOSSEE ROAD
 ORLANDO, FLORIDA 32822
 CTIA No. 1743W-1743W-1
 Date Verified: 9.24.07
 Verified By: K-10

CTL
 017

FOR F360/F362: Install Inside Housing

- a. Slide housing into door so housing tab inserts into outside housing groove.
- b. Insert two (2) screws and tighten.
- c. Check function. If bolt does not fully retract, see step 8a. If operation is not smooth, adjust assemblies until "Schlage" logo on outside housing is horizontal.
- d. FOR F362: Insert drive screws into screw holes and tap flush.

PARA LOS MODELOS F360/F362: Instalación del dispositivo de mariposa O del alojamiento interior

- a. Deslizar el alojamiento en la puerta de tal modo que la lengüeta de aquí se inserte en la ranura del alojamiento exterior.
- b. Introducir dos (2) tornillos y apretarlos.
- c. Verificar su funcionamiento. Si el pasador no se retrae por completo, consultar el paso 8a. Si el funcionamiento no es fluido, ajustar los conjuntos hasta que el logotipo "Schlage" en el alojamiento exterior quede horizontal.
- d. PARA F362 SOLAMENTE: Introducir los tornillos de inserción en los agujeros correspondientes y golpearlos levemente para que queden al ras.

POUR F360/F362: Installer le tourniquet OU le logement Intérieur

- a. Faire glisser le logement sur la porte de sorte que l'onglet du logement s'insère dans la gorge du logement extérieur.
- b. Insérer deux (2) vis et serrer.
- c. Vérifier le fonctionnement. Si le pêne ne se rétracte pas complètement, voir l'étape 8a. Si le fonctionnement ne se fait pas en souplesse, régler les modules jusqu'à ce que le logo "Schlage" du logement extérieur soit à l'horizontale.
- d. POUR F362 UNIQUEMENT: Insérer les vis d'entraînement par les trous de vis et taper dessus pour qu'elles affleurent.

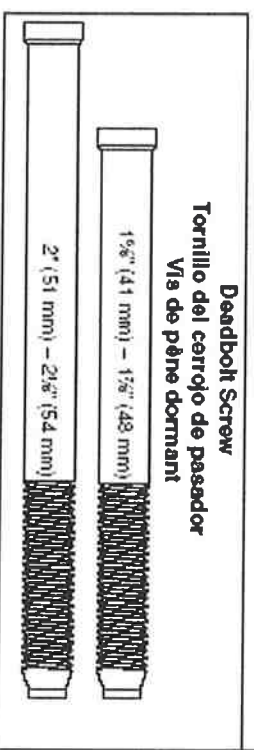
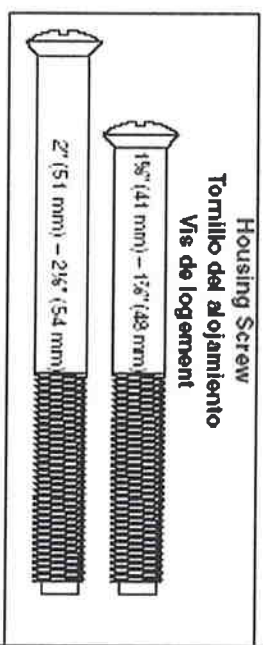
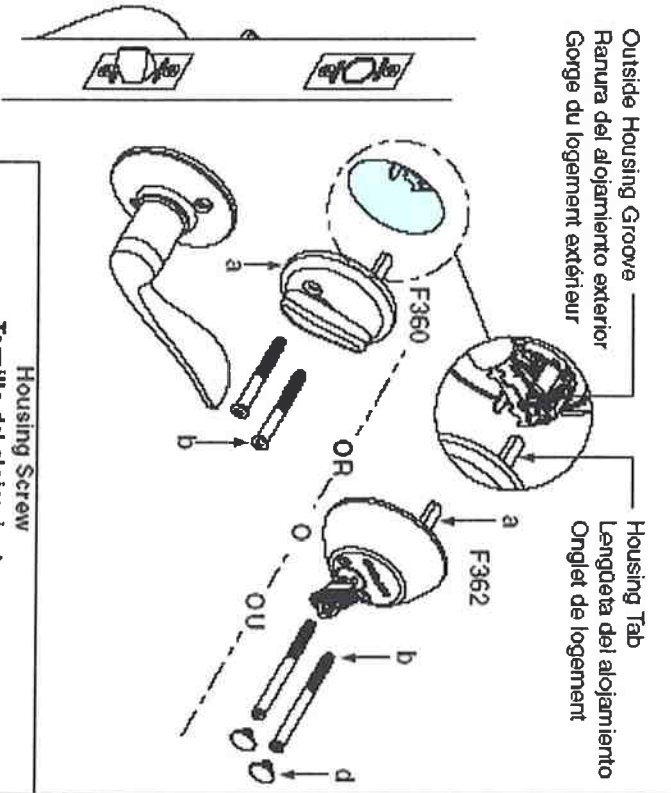

CTI
 ESTIMATED
 LABOR HOURS

ARCHITECTURAL DIVISION
 7252 NARCOOSSEE ROAD
 ORLANDO, FLORIDA 32822

CTIA No. 1743W-1743W-1
 Date Verified: 9-24-07
 Verified By: K-ID

Glass*Craft
 Portobello / Estancia Arch Top
 Hardwood Double Glazed Doors

CTI-017A

Install Outside Housing

NOTE: Do not install adapter ring if using 1½" (38 mm) hole.

- FOR F360/F362: Ensure pin is positioned to slide through correct backset slot in deadbolt.
- Insert housing through escutcheon and adapter ring and into door. Driver bar should slide under deadbolt.

Instalación del alojamiento exterior

NOTA: Si se usa un agujero de 38 mm no se instala un anillo adaptador.

- PARA LOS MODELOS F360/F362: Se debe verificar que el pasador está colocado de manera que se deslice a través de la ranura en el pasado que corresponda a la distancia correcta del borde de la puerta al centro de la bocallave.
- Introducir el alojamiento en la puerta, a través del escudo y del anillo adaptador. La barra impulsora debe deslizarse debajo del pasado.

Installation du logement extérieur

REMARQUE: Ne pas installer l'anneau adaptateur si le trou 38 mm est utilisé.

- POUR les modèles F360/F362: S'assurer que la broche est placée de sorte à glisser dans la fente d'écartement correct du pêne dormant.
- Insérer le logement par l'entrée de serrure et l'anneau adaptateur et dans la porte. La barre d'entraînement doit glisser sous le pêne dormant.

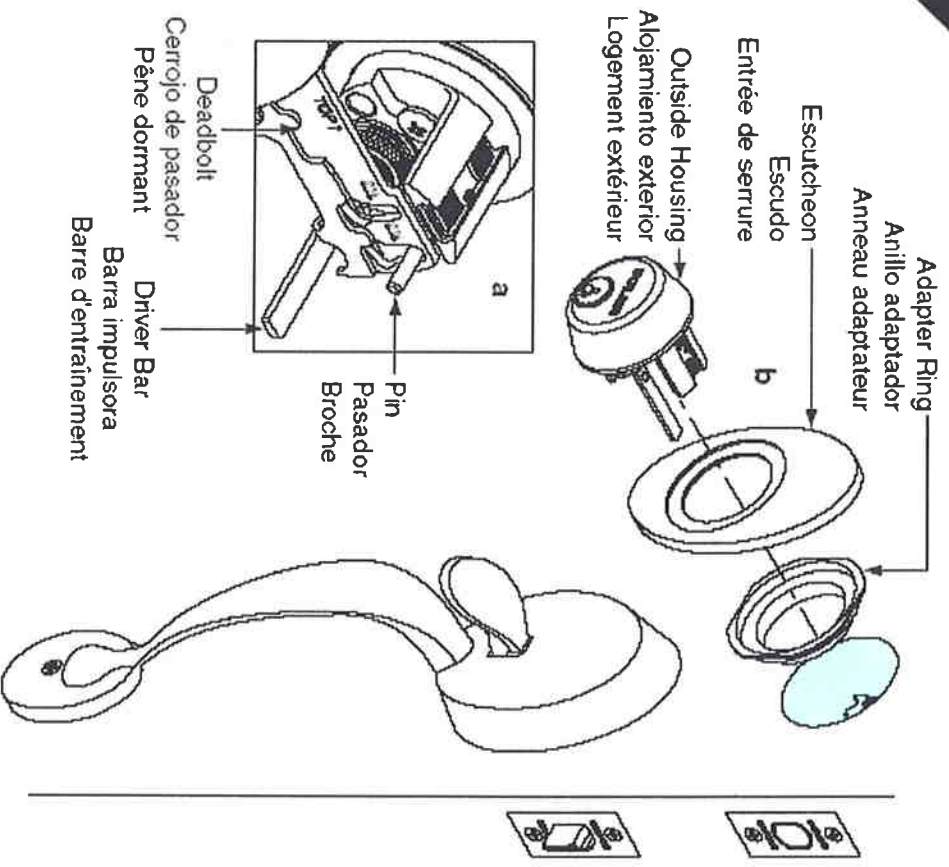

ARCHITECTURAL DIVISION
7252 NARCOOSSEE ROAD
ORLANDO, FLORIDA 32822

CTIA No. 1743W-1743W-1

Date Verified: 4.24.07

Verified By: V-0

Glass*Craft
Portobello / Estancia Arch Top
Hardwood Double Glazed Doors

CTI-0778

